



S1 Electric Trolley
Instruction Manual

EN

REGISTER ONLINE
www.motocaddy.com/warranty

Visit www.motocaddy.com/instructions for other Motocaddy instructions including translations

Contents

Locating your Serial Number.....	3	Upper & Lower Bag Supports.....	12
Safe use of your Trolley / Trolley Care.....	4	Adjusting the Bag Supports.....	13
Trolley Care / Battery Care & Advice.....	5	Equipment Overview	14
Charging Instructions / Lithium Battery Care	6	Starting, Stopping & Changing Speed	15
Lithium Battery Care	7	Battery Meter / Battery Setting.....	16
Attaching the Wheels.....	8	Adjustable Distance Control.....	17
Adjusting the Front Wheel Alignment.....	9	USB Charging	18
Unfolding your Trolley.....	10	Declaration of Conformity.....	19
Folding your Trolley.....	11		

Locating your Serial Number

The serial number for your Motocaddy trolley is located on the underside of the battery tray. This number is required when registering your warranty online and should be kept handy for future use.

The same number should also be on the box received with your trolley. Please ensure you keep hold of the packaging in case you need to return your trolley for any reason. A proof of purchase must also be kept in case your trolley requires servicing during its warranty period.

Please keep a record of your trolley serial number here for future reference

M	C	S												
---	---	---	--	--	--	--	--	--	--	--	--	--	--	--

Safe use of your Trolley / Trolley Care

Safety cut-out

This Motocaddy trolley is fitted with a timed safety cut-out feature. Once started the trolley will automatically cut power to the motor after ten minutes to prevent any possible damage to the trolley. Pressing the on/off button will restart the trolley.

Safe use of your Trolley

Motocaddy trolleys are designed for the transportation of golf bags and clubs contained within. Using the trolley for any other purpose may cause damage to the trolley and cause harm to the user.

- Do not attempt to transport any other equipment
- The trolley is not designed for the transportation of people
- Do not use the trolley to assist you when going up hills
- Submerging the trolley in water (e.g. a lake) is likely to cause damage to the trolley
- Do not operate the trolley whilst under the influence of drugs or excessive amounts of alcohol
- **All batteries must be disconnected from the trolley before folding, storage and transportation**

Caring for your Trolley

Although your Motocaddy trolley has been weatherproofed, please follow these simple guidelines to help protect your trolley:

- Do not store your trolley outside
- Try to minimise exposure to rain as much as possible with an umbrella during heavy rainfall
- Wipe excess water from the trolley prior to storage
- Never use a pressure washer to clean your trolley. To prevent water damage, wipe down with a damp cloth
- Avoid using high pressure air hoses near moving components

This Motocaddy trolley is designed to require very little maintenance. We do however recommend giving your trolley regular checks to ensure:

- There is no build up of excess mud and dirt
- The front wheel nut is on tightly and quick release lever is clamped down
- The front wheel is not clogged up and turns freely
- The QUIKFOLD track is kept clean and well lubricated

Only original Motocaddy parts should be used when repairing your trolley.

Battery Care & Advice

All batteries must be charged as soon as possible after each use. Leaving batteries discharged for long periods of time will affect the battery life.

Please ensure that only batteries supplied by Motocaddy are charged with Motocaddy chargers. Cyclic battery chargers are designed specifically in accordance with the battery manufacturer's requirements. The Lithium battery charger **MUST NOT** be used to charge any other battery and is designed for use with Motocaddy Lithium batteries only.

The charger should only be connected to an earthed socket outlet; the battery charger should only be opened and maintained by authorised personnel. Unauthorised opening will invalidate your warranty.

The battery must be stored and charged on a dry non-carpeted surface and charged at temperatures ranging between 10°C and 30°C. Charging above or below these temperatures is not recommended as it can reduce the battery capacity.

When connecting your battery to the trolley, please ensure that the connections match up black to black and colour to colour.

Charging your Lithium Battery / Lithium Battery Care

Charging your Lithium Battery

1. Unplug the Lithium battery from the trolley. This should always be performed before folding the trolley to avoid damage to the battery and/or trolley
2. Plug the charger into your mains supply
3. Attach the battery cable to the charger matching black to black and colour to colour
4. When the charging LED indicator has turned green, the battery is fully charged and ready to be used

 RED - Battery charging   GREEN - Battery fully charged and ready to be disconnected

5. The charging process will take between 3 to 5 hours depending on the depth of discharge (please be aware that this may take longer for the first few charges)
6. Once charging is complete please disconnect the charger from the mains power supply
7. Finally disconnect the charger from the battery

If you connect the battery to the charger and the LED goes out, this is likely to indicate that the battery is fully charged. Please double check the battery on the trolley to ensure that it is fully working.

Caring for your Lithium Battery

- Try to avoid getting the battery too wet (i.e. do not submerge the battery, avoid deep puddles and do not clean your trolley whilst the battery is still in the battery tray)
- Dropping the battery may cause damage to the internal cells
- Do not lift or carry the battery by the cable
- Use a damp cloth to clean off any dirt

Recommendations for hibernation of Lithium Batteries during winter months

If for any reason your Lithium battery is not going to be used for lengthy periods, e.g. 3 months over the winter, it is advised to store the battery half charged. To do this simply use the battery for a round of golf as usual and charge it for 1.5 hours at the end of the round. Before the battery is used again, recharge it (top it up) prior to use.

We recognise that extended absences are not always planned in advance, however when it is likely that you will not be using your battery for a period of time it is good practice to follow these steps to extend the life of your Lithium battery. Please ensure that the charger is ALWAYS disconnected from the battery after charging.

Battery Management System (BMS)

Motocaddy Lithium batteries are fitted with a comprehensive battery management system (BMS) to protect the battery from excessive abuse, high currents, deep discharge and overcharge. When the battery is delivered there may be no output as the BMS is designed to maximize safety whilst shipping. Please ensure that the battery is fully charged prior to connecting it to your trolley as this will activate the BMS and effectively 'switch-on' the battery. From time to time, at deep discharge or long term storage the BMS may switch-off the battery. A full battery charge will rectify this problem.

Motocaddy golf trolleys are designed to work with the BMS system installed in the Lithium batteries and the voltage meter is also synchronised to work in conjunction with the battery. If for any reason the voltage on the battery falls below the low battery warning on the trolley, then the BMS may disable the battery to protect it. Again if this occurs please recharge fully. Please be aware that Lithium batteries tend to 'drop off' quickly at the end of the cycle so it is not advisable to attempt to play excessive holes as the BMS will activate for protection purposes.

Attaching the Wheels

Attaching the Wheels

There is a left and a right wheel and it is important that you don't put them on the wrong way round, otherwise the trolley will not move.

There is an 'L' and 'R' on the inside of the wheel on the central hub. Left and Right sides are determined when stood behind the trolley at the handle.

To attach the wheels, follow these simple steps:

1. Push the quick release in towards the centre of the wheel
2. Slide the wheel on to the axle as far as it will go
3. Release the button and pull the wheel outwards slightly to lock
4. You will hear a small click which will confirm they are in the correct position

The outer groove can be used as a 'free-wheel' option if you run out of battery power during a round of golf.

To check you have attached the wheels correctly onto the inner groove, you will find they will only rotate freely in one direction.

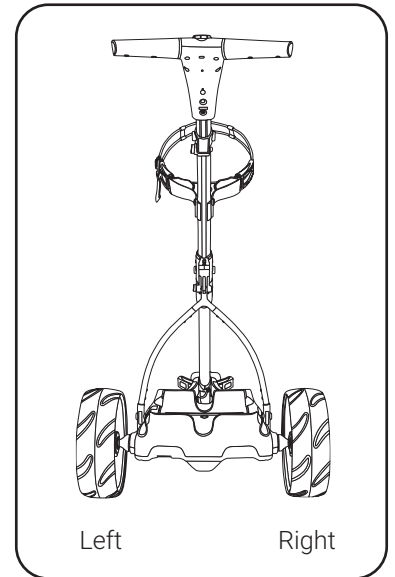

Adjusting the Front Wheel Alignment

In the unlikely event that your trolley is not tracking in a straight line, the alignment of the front wheel can be adjusted to rectify the fault. This problem can be caused by a number of factors including a slightly loose bag support or an unevenly packed golf bag.

To alter the alignment of the front wheel, follow these simple steps:

1. Lift the quick release lever positioned on the front wheel housing and loosen the wheel nut (fig. 1)
2. There are two small metal dials on either side of the housing that are used to realign the wheel (fig. 2)
3. If your trolley is veering to the right, you will need to turn the left hand dial clockwise and the right hand dial anti-clockwise
4. If your trolley is veering to the left, you will need to turn the right hand dial clockwise and the left hand dial anti-clockwise
5. Tighten the wheel nut and push down the lever to lock the wheel back into place (fig. 3)

This procedure can be carried out until you are happy the trolley is moving in a straight line (please note you may only need to adjust one dial at a time).

These instructions are based on positioning yourself in front of the trolley looking at the wheel.

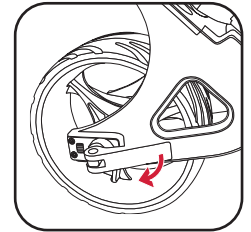

Fig 1

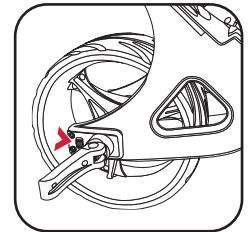

Fig 2

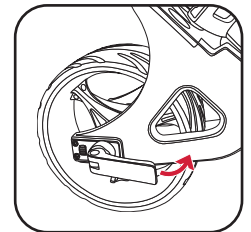

Fig 3

Unfolding your Trolley

This Motocaddy trolley is fitted with the QUIKFOLD system, allowing you to fold and unfold your trolley quicker than ever before.

Unfolding your Trolley

1. Press and hold the upper QUIKFOLD release button (fig. 1)
2. Lift the handle and release the button (fig. 2)
3. Unfold the upper frame section **fully** (fig. 3)
4. Lift the main frame from the central hinge using the section marked 'HOLD HERE' until the QUIKFOLD system clicks in place.
Do not hold/touch the trolley anywhere else during this process (fig. 4)
5. Unfold the upper bag support

Do not lift from the handle (step 4 above) as this will complicate the folding process and may damage your trolley.

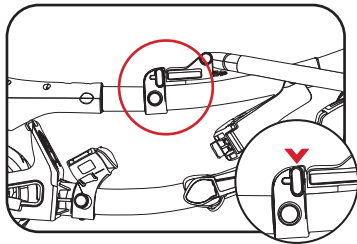

Fig 1

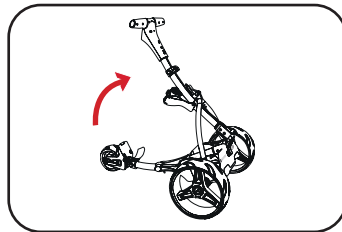

Fig 2

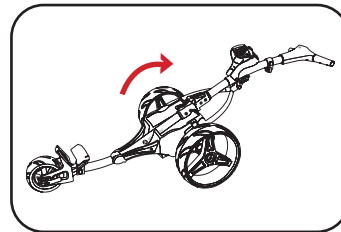

Fig 3

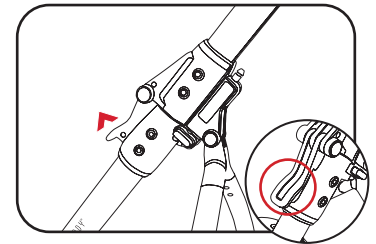

Fig 4

Folding your Trolley

1. Make sure your battery is unplugged
2. Ensure that the upper bag support has been folded up to avoid damage to the frame whilst folding
3. Press and hold the lower QUIKFOLD release button (fig. 1)
4. Lower the main frame **completely**, releasing the button at any point (fig. 2)
5. Once the frame is **completely flat**, fold the handle towards the front wheel until the QUIKFOLD system clicks in place (fig. 3)
6. You may need to gently push as indicated if you do not hear a click (fig. 4)

To avoid injury, it is very important to ensure the latch has clicked in place securely before carrying.

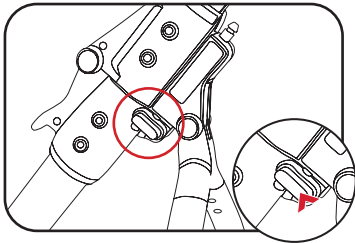

Fig 1

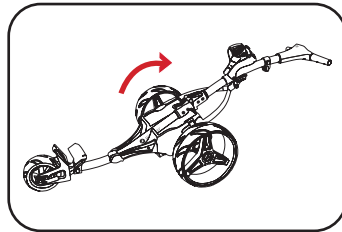

Fig 2

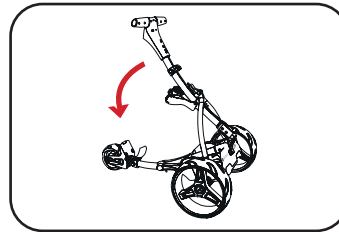

Fig 3

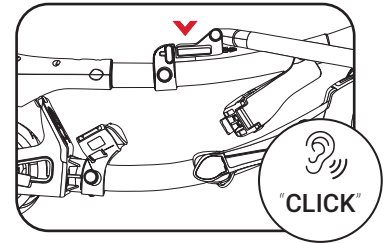

Fig 4

Upper & Lower Bag Supports

Upper Bag Supports

The upper bag support straps are secured using the following steps:

1. Stretch the elasticated strap around the bag & loop the rounded bar underneath the hook (fig. 1)
2. Position the two placement straps centrally on your golf bag (fig. 2)

Lower Bag Supports

This Motocaddy trolley is fitted with the EASILOCK™ bag attachment system.

If you are using an EASILOCK™ compatible golf bag please follow these simple instructions:

1. Remove the two pre-fitted lower bag straps by depressing the rear button and sliding (fig. 3)
2. Match up the indicating line on the golf bag with the line on the lower bag support
3. Lower the bag until the pins lock in position. You should hear an audible 'click'

If you are using a non-EASILOCK™ golf bag, please use the following instructions:

1. Stretch the lower bag strap around the bag base & loop the rounded bar underneath the hook
2. Position the two placement straps centrally on the base of your golf bag

Please ensure all straps are hooked securely before releasing. Failure to do so could result in injury.

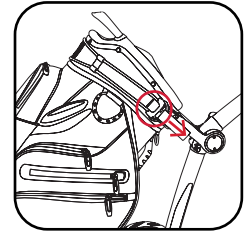

Fig 1

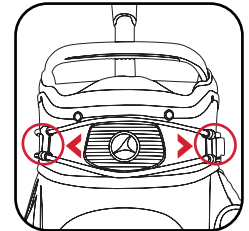

Fig 2

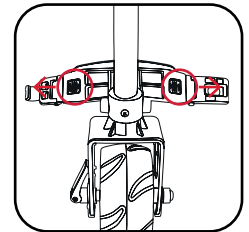

Fig 3

Adjusting the Bag Supports

The bag support straps are manufactured from elasticated material to allow your golf bag to be held tightly in position.

The strap should be adjusted to be reasonably tight around the golf bag:

1. Unclip the elasticated straps from the housing by pulling outwards in the direction shown (fig. 1)
2. Move the bar as required to tighten or loosen the strap fitting. Pulling the bar downwards will tighten, pushing it upwards will loosen (fig. 2)
3. Ensure that the straps are clipped back into the housing before use (fig. 3)

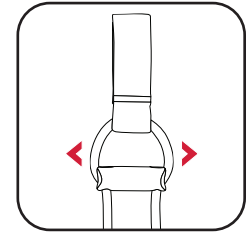

Fig 1

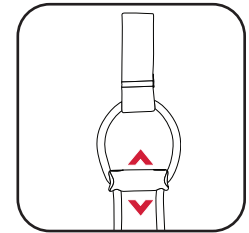

Fig 2

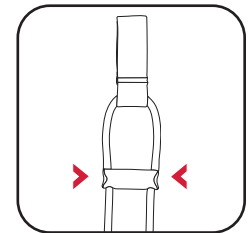
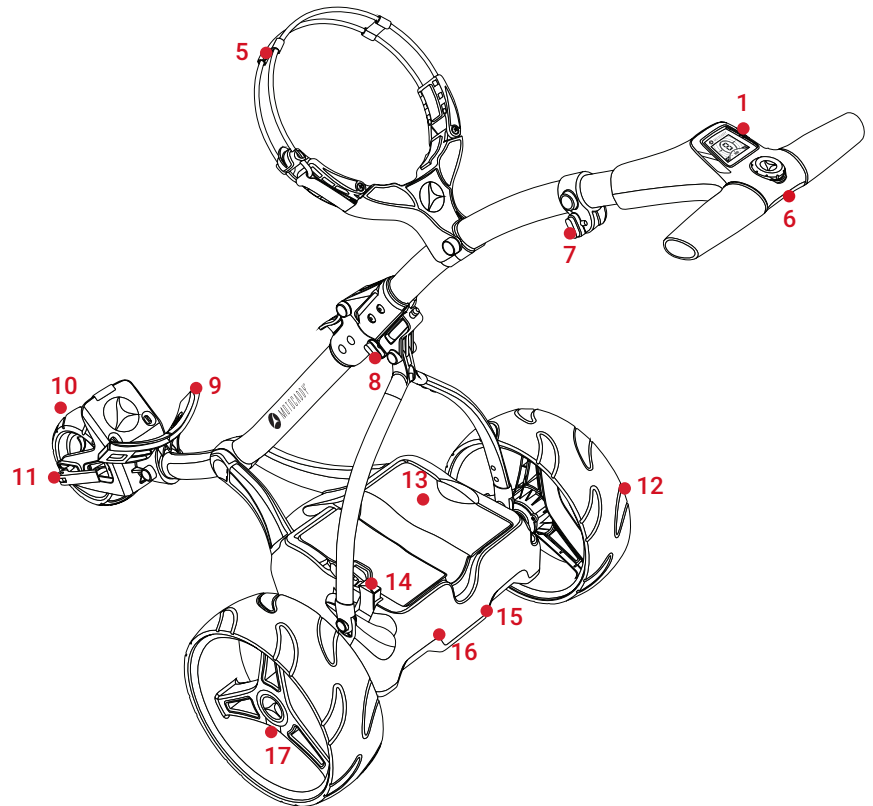

Fig 3

Equipment Overview

1. LCD Digital Display
2. Speed Setting (see pg 15)
3. Advanced Battery Meter (see pg 15)
4. Speed Controller & On/Off Button (see pg 15)
5. Upper Bag Support
6. USB Charging Port (under handle)
7. QUIKFOLD Upper Release Button
8. QUIKFOLD Lower Release Button
9. EASILOCK™ Lower Bag Support
10. Front Wheel
11. Front Wheel Alignment Adjusters
12. Rear Wheel
13. Battery
14. Battery Connector
15. Motor (located under Battery Tray)
16. Battery Tray
17. Rear Wheel Release Button



Starting, Stopping & Changing Speed

The S1 is very simple to control. There is one main button that is used to start and stop the trolley, whilst also controlling the speed, which can be adjusted while the trolley is stationary or in motion.

The trolley has 9 speed settings (1 to 9) with 1 being the slowest and 9 the fastest. To increase the speed, rotate the speed dial clockwise, or anti-clockwise to decrease the speed.

To start the trolley, simply select your required speed setting and press the button. The trolley will smoothly accelerate until it reaches the selected speed. To stop the trolley, simply press the button again - there is no need to reduce the speed setting.

The red chevrons will start flashing when you press the button. This indicates that the trolley has been started.

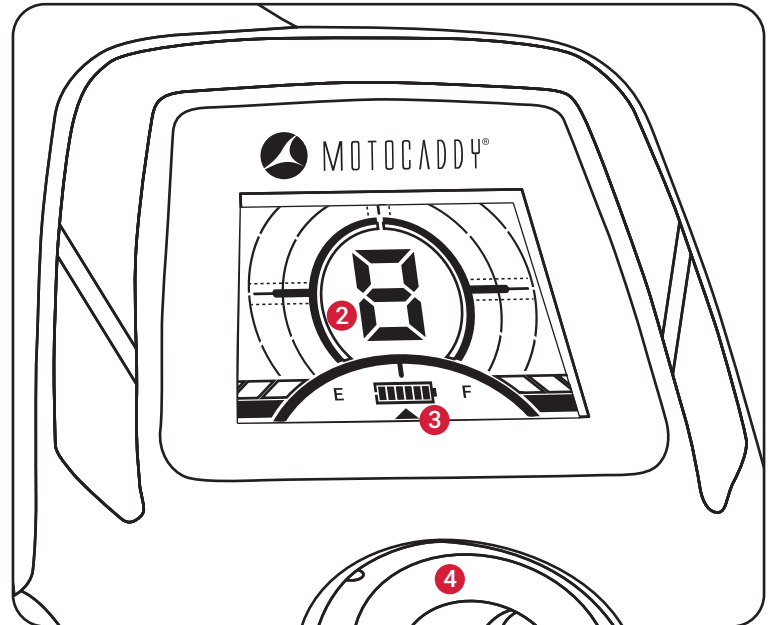

Battery Meter / Battery Setting

Battery Meter

The S1 includes an on-screen battery meter which provides an indication of remaining battery capacity. The number of illuminated bars will decrease as the battery capacity reduces.

A fully charged battery will show two red and four green bars.

The trolley is designed to protect your battery from being fully discharged, should your battery capacity drop too low the trolley will cut the power to the motor. If this should happen you will see the battery meter flashing on screen. (fig. 1 & 2). Please charge your Lithium battery before further use.

Please be aware that certain moisture, temperature and humidity conditions can result in localised misting within the display screen. This will not affect the trolley functionality, nor cause any damage and will return to normal when adverse conditions subside.

Battery Setting

The battery meter needs to be set to measure capacity based on the type of Lithium battery being used. When the battery is connected to the trolley, the Speed Setting will briefly show 'n' (fig. 3) or 'P' to indicate the current setting. It needs to be set to 'n' for use with 14.4V batteries or 'P' for use with 12.8V batteries. The voltage is listed on the underside of the battery casing. To change the battery setting:

1. Push and hold the On/Off button, connect the battery and release the On/Off button
2. The Speed Setting on the digital display will show 'n' (for 14.4V batteries) or 'P' (for 12.8V batteries)
3. Press the On/Off button down to toggle between these two settings
4. Disconnect the battery to store the chosen setting



Fig 1



Fig 2



Fig 3

Adjustable Distance Control

This trolley features a basic, easy to use adjustable distance control which will allow you to send your trolley ahead of you from 15 - 45 yards.

1. While stationary select the speed that you wish your trolley to set off at
2. Hold down the on/off button for 3 seconds, the number "1" will flash on the display (fig. 1). There are three settings for the distance, 1 = 15 yards, 2 = 30 yards and 3 = 45 yards
3. Turn the button clockwise to increase and anti-clockwise to decrease to your preferred distance
4. Press the on/off button to set the trolley in motion. While the trolley is powered using ADC, the red chevrons will flash in unison
5. The trolley can be stopped manually by pressing the button again

In the unlikely event that your trolley fails to register distance whilst in ADC mode, the trolley will cut power to the motor to prevent the trolley from travelling too far. The trolley screen will flash "E" to indicate that this safety feature has been activated (fig. 2).

The trolley can be reset by pressing the on/off button once, thereby allowing you to continue to use the trolley with ADC disabled until you are able to contact our technical support team.



Fig 1



Fig 2

USB Charging Port

This trolley features a USB charging port designed to charge USB powered devices during your round.

Simply remove the covering cap and plug a USB cable into the charging port located on the underside of the handle. The device will continue charging while the cable is attached and the battery is connected.

The rate of charge will be slower than a mains AC charger and similar to plugging the device into a PC. The USB charger takes power from the main trolley battery and continuous charging will reduce the battery capacity between charges. The trolley is designed to disable the USB port when the battery capacity reaches a preset level.



DECLARATION OF CONFORMITY

ORIGINAL

Business Name and Full Address of Manufacturer

Motocaddy Ltd - Units 15-18 Stansted Distribution Centre,
Start Hill
Great Hallingbury

Hertfordshire
CM22 7DG

Name and Address of Authorised Representative

-

Name and Address of the Person in Community Authorised to compile the Technical File (if different to above)

-

Description of product (Commercial Name)

Motocaddy Electric Trolley

Function, Model, Type, Serial Number

Function: Electric Trolley

Model: S1/S1 DHC/S3 PRO/S3 PRO DHC/
S5 CONNECT/S5 CONNECT DHC/S7 REMOTE/
M1/M1 DHC/M3 PRO/M3 PRO DHC/
M5 CONNECT/M5 CONNECT DHC/M5 GPS/
M5 GPS DHC/M-TECH/C-TECH/M7 REMOTE

Type: Motocaddy Digital Range

Standards Used

BS EN ISO 12100 2010

Place of Declaration

Units 15-18 Stansted Distribution Centre,
Start Hill
Great Hallingbury

Hertfordshire
CM22 7DG

Date of Declaration Wednesday January 01, 2020

Declaration

I declare that the machinery fulfils all the relevant provisions of the following Directives:- Low Voltage Directive 2006/95/EC, Electromagnetic Compatibility Directive 2004/108/EC.

Person Empowered to Draw Up Declaration

Name: John Helas

Position: Managing Director

Signature:



Motocaddy Ltd, Units 15 - 18 Stansted Distribution Centre,
Start Hill, Great Hallingbury, Hertfordshire, CM22 7DG, United Kingdom

t: +44 (0)1279 712 370 e: info@motocaddy.com w: www.motocaddy.com



We are dedicated to protecting the environment and encourage the recycling of Motocaddy products through a free collection and disposal service. To find out more or to locate your nearest Motocaddy recycling point, please contact us through our website.

MC.20.61.001

EASILOCK™ Patent (GB) - GB2519073
USB Charging Port Patent (GB) - GB2473845
USB Charging Port Patent (AUSTRALIA) - 2010224448